

代号/SYMBOL 型号/MODE	Ⓐ	Ⓑ	Ⓒ	Ⓓ	Ⓔ	Ⓕ	Ⓖ	Ⓗ	Ⓘ	Ⓢ
STM-607	10.0	2.5	16	0.55	1.0	6	9	1.5	2.5	20
STM-910	15.3	4.0	25	0.75	1.8	9	13.5	1.5	2.5	25
STM-1220	21.2	6.0	32	1.5	3.4	12	18	1.5	4.0	32

					制图	版号	D	标题	STM-607/910/1220-EB	图号	STM-607/910/1220-EB-400V-D-1	比例	第 1 张
					设计	核		主电路图				标准	GB
					校对	准						机器电压	3/N/400V
标记	更改前	更改后	更改人	日期	审核	日期	20221013					机器频率	50Hz

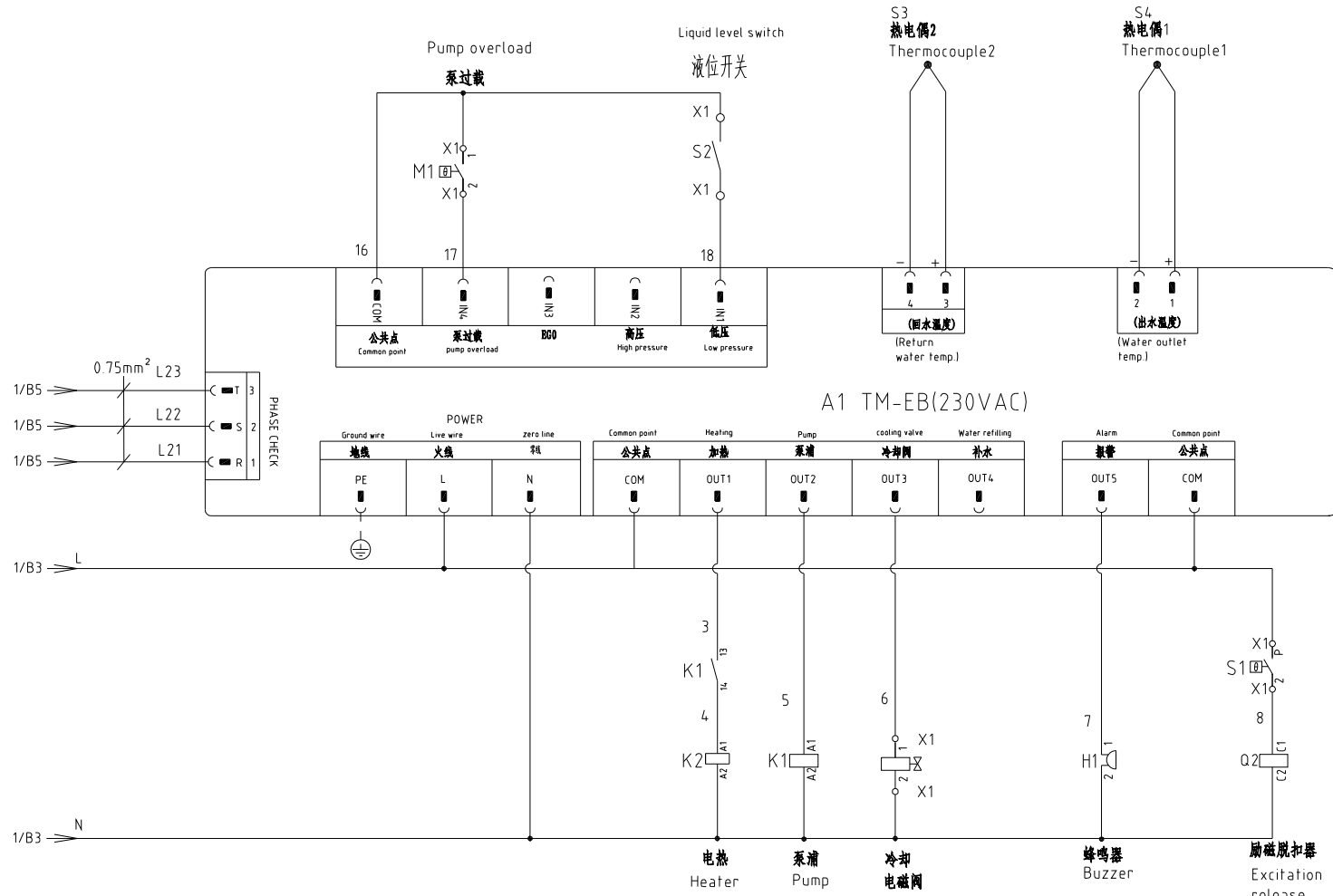



注：M1为水泵电机过热保护输出接点。

Note: M1 is the overhear protection output contact of water pump.

					制图	版号	D	标题	图号	比例	第 2 张
					设计	核准		STM-607/910/1220-EB	STM-607/910/1220-EB-400V-D-2	标准	共 5 张
					校对			信易电热机械股份有限公司 Shini Plastics Technologies, Inc.	机器电压	3/N/400V	
标记	更改前	更改后	更改人	日期	审核	日期	20221013		机器频率	50Hz	

技术要求：(1)热电偶正(+)负(-)极直接接到线路板的热电偶输入端，不经过端子排。

(2)电热和泵浦直接接接触器输出端。

Technical requirements:

(1) Positive (+) and negative (-) poles of thermocouple should be directly connected to thermocouple's input terminal of circuit board. There is no need for them to go through the terminal board.

(2) the heater and bump directly connect to contactor output.

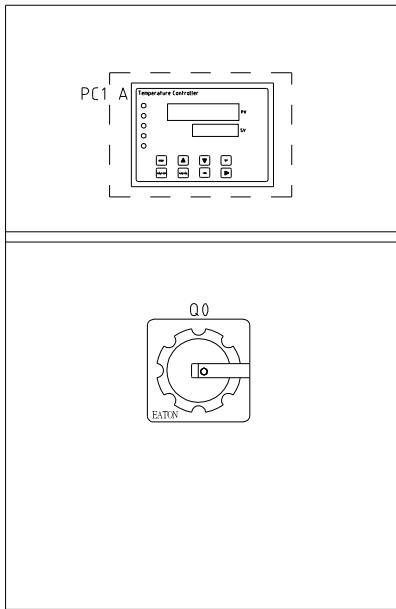

电箱面板
Electric box panel

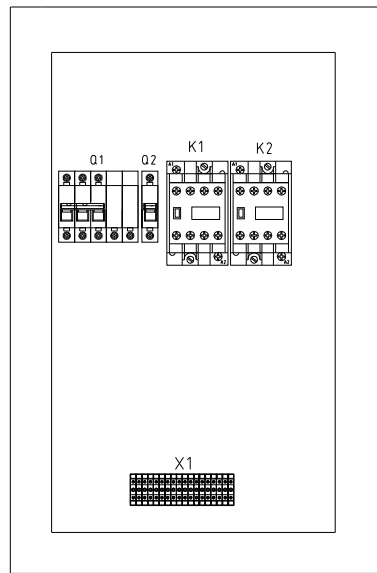

电箱底板
Base plate of electrical box

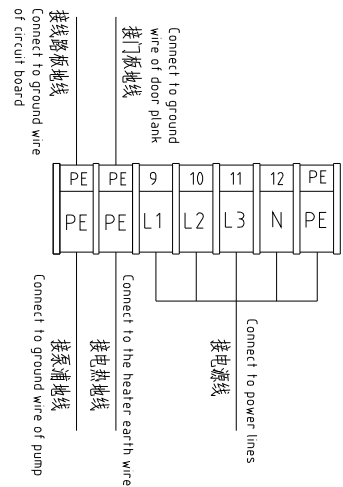
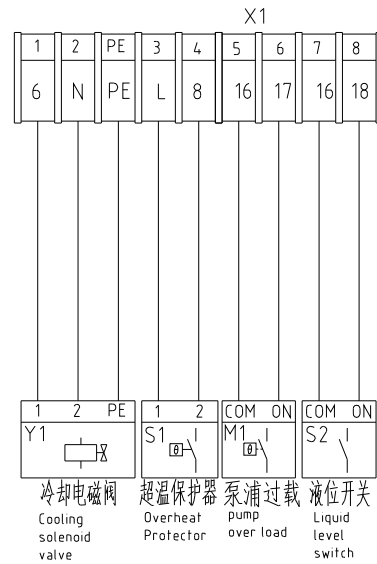

					制图	版号	D
					设计	核准	
					校对		
标记	更改前	更改后	更改人	日期	审核	日期	20221013

标题 STM-607/910/1220-EB
图号 STM-607/910/1220-EB-400V-D-3
电气布置及端子接线图



信易电热机械股份有限公司
Shini Plastics Technologies, Inc.

比例	第 3 张
标准 GB	共 5 张
机器电压	3/N/400V
机器频率	50Hz

1	2	3	4	5	6	7	8		
序号/NO	符号/Symbol	名称/Name	制造商/Manufacturer	型号/Type	规格/Specification	数量/Number	物料编号/Material number	备注/Remark	
A	1	断路器/Circuit Breakers	TECO	BM-63C	16A	1	YE40301603000	607-EB用 for 607-EB	
	2	断路器/Circuit Breakers	TECO	BM-63S	25A	1	YE40302503000	910-EB用 for 910-EB	
	3	断路器/Circuit Breakers	TECO	BM-63C/3032S	32A	1	YE40303203000	1220-EB用 for 1220-EB	
	4	励磁脱扣器/Excitation release	CHINT	MX	230VAC	1	YE40023560000		
	5	断路器/Circuit Breakers	TECO	BM-63C/1003S	3A	1	YE40100203000		
	6	K1	接触器/Contactors	SIEMENS	3RT6015-1AN21	220V 50/60Hz	1	YE00601521000	
	7	K2	接触器/Contactors	SIEMENS	3RT6018-1AN21	220V 50/60Hz	1	YE00601800000	607-EB用 for 607-EB
B	8	接触器/Contactors	SIEMENS	3RT6026-1AN20	220V 50/60Hz	1	YE00602622000	910-EB用 for 910-EB	
	9	接触器/Contactors	SIEMENS	3RT6027-1AN20	220V 50/60Hz	1	YE00602722000	1220-EB用 for 1220-EB	
	10	A1 TM-EB	线路板/Circuit Board	YUYUN	TM-EB 220VAC 宇韻 YuYun	180~430V 50/60Hz	1	YE81081100100	
	11	S1	突跳式超温保护器/Snap action overheat protector	---	KSD301-20.5/10BL16K30-G/205/常开 normally open	205℃	1	YE90030100300	(1)
	12	S2	微动开关/Micro switch	JUCHE	LXW5-1124 桿長 rod length : 100MM	250V 50HZ	1	YE14152400000	(1)
	13	S3	热电偶/Thermocouple	SHINI	----	K	1	----	(1) (2)
	14	S4	热电偶/Thermocouple	SHINI	----	K	1	----	(1) (2)
	15								
C	16	X1	端子排/Terminal Board	PHOENIX	2.5mm ²	----	12	YE61250040000	607-EB用 for 607-EB
	17		接地端子排/Grounding terminal board	PHOENIX	2.5mm ² PE	----	4	YE61253500000	607-EB用 for 607-EB
	18		端子排/Terminal Board	PHOENIX	2.5mm ²	----	8	YE61250040000	910-EB用 for 910-EB
	19		接地端子排/Grounding terminal board	PHOENIX	2.5mm ² PE	----	1	YE61253500000	910-EB用 for 910-EB
	20		端子排/Terminal Board	PHOENIX	4.0mm ²	----	4	YE61040000000	910-EB用 for 910-EB
	21		接地端子排/Grounding terminal board	PHOENIX	4.0mm ² PE	----	3	YE61043500000	910-EB用 for 910-EB
	22		端子排/Terminal Board	PHOENIX	2.5mm ²	----	8	YE61250040000	1220-EB用 for 1220-EB
	23		接地端子排/Grounding terminal board	PHOENIX	2.5mm ² PE	----	1	YE61253500000	1220-EB用 for 1220-EB
	24		端子排/Terminal Board	PHOENIX	6mm ²	----	4	YE61060000000	1220-EB用 for 1220-EB
	25		接地端子排/Grounding terminal board	----	6mm ² PE	----	3	YE61063500000	1220-EB用 for 1220-EB

注: (1)表示非电控箱内材料; (2)表示选配出水 and 回水温度显示功能;
Notes: (1)Means it's not the material inside the control box. (2)Means equipped with function of displaying water outlet and return water temperature.

D						制图	版号	D	标题	图号	比例	第 4 张			
						设计	核		STM-607/910/1220-EB	STM-607/910/1220-EB-400V-D-4	标准	共 5 张			
						校对	准		元件明细表一		GB				
	标记	更改前	更改后	更改人	日期	审核	日期	20221013	 信易電熱機械股份有限公司 Shini Plastics Technologies, Inc.		机器电压	3/N/400V			
								机器频率			50Hz				
1		2		3		4		5		6		7		8	

1	2	3	4	5	6	7	8	
序号/NO	符号/Symbol	名称/Name	制造商/Manufacturer	型号/Type	规格/Specification	数量/Number	物料编号/Material number	备注/Remark
A	M1	马达/Motor	SHINI	TP-55	400V 50Hz 0.55kW	1	----	(1) 607-EB用 for 607-EB
		马达/Motor	SHINI	TP-75	400V 50Hz 0.75kW	1	----	(1) 910-EB用 for 910-EB
		马达/Motor	SHINI	TP-150	400V 50Hz 1.5kW	1	----	(1) 1220-EB用 for 1220-EB
	EH	电热/Heater	SHINI	6kW	400V 50Hz	1	----	(1) 607-EB用 for 607-EB
		电热/Heater	SHINI	9kW	400V 50Hz	1	----	(1) 910-EB用 for 910-EB
		电热/Heater	SHINI	12kW	400V 50Hz	1	----	(1) 1220-EB用 for 1220-EB
	H1	蜂鸣器/Buzzer	SHINI	PF-35A	230VAC 50Hz	1	YE84003500000	
B	Y1	电磁阀/Solenoid Valve	----	----	230VAC 50/60Hz	1	----	(1)
	Q0	主电源开关/Main power switch	EATON	T0-2-1/EA/SVB	20A	1	YE1 0021160000	607W-EB用 for 607W-EB
		主电源开关/Main power switch	EATON	P1-25/EA/SVB	25A	1	YE10125250000	910W-EB用 for 910W-EB
		主电源开关/Main power switch	EATON	P1-32/EA/SVB	32A	1	YE10323200000	1220W-EB用 for 1220W-EB
C								
D								

注: (1)表示非电控箱内材料; (2)表示选配出水 and 回水温度显示功能;
Notes: (1)Means it's not the material inside the control box. (2)Means equipped with function of displaying water outlet and return water temperature.

					制图	版号	D	标题	STM-607/910/1220-EB	图号	STM-607/910/1220-EB-400V-D-5	比例	第 5 张
					设计	核		元件明细表二		标准	GB	共 5 张	
					校对	准		 信易電熱機械股份有限公司 Shini Plastics Technologies, Inc.	机器电压	3/N/400V			
标记	更改前	更改后	更改人	日期	审核	日期	20221013		机器频率	50Hz			
1	2	3	4	5	6	7	8						

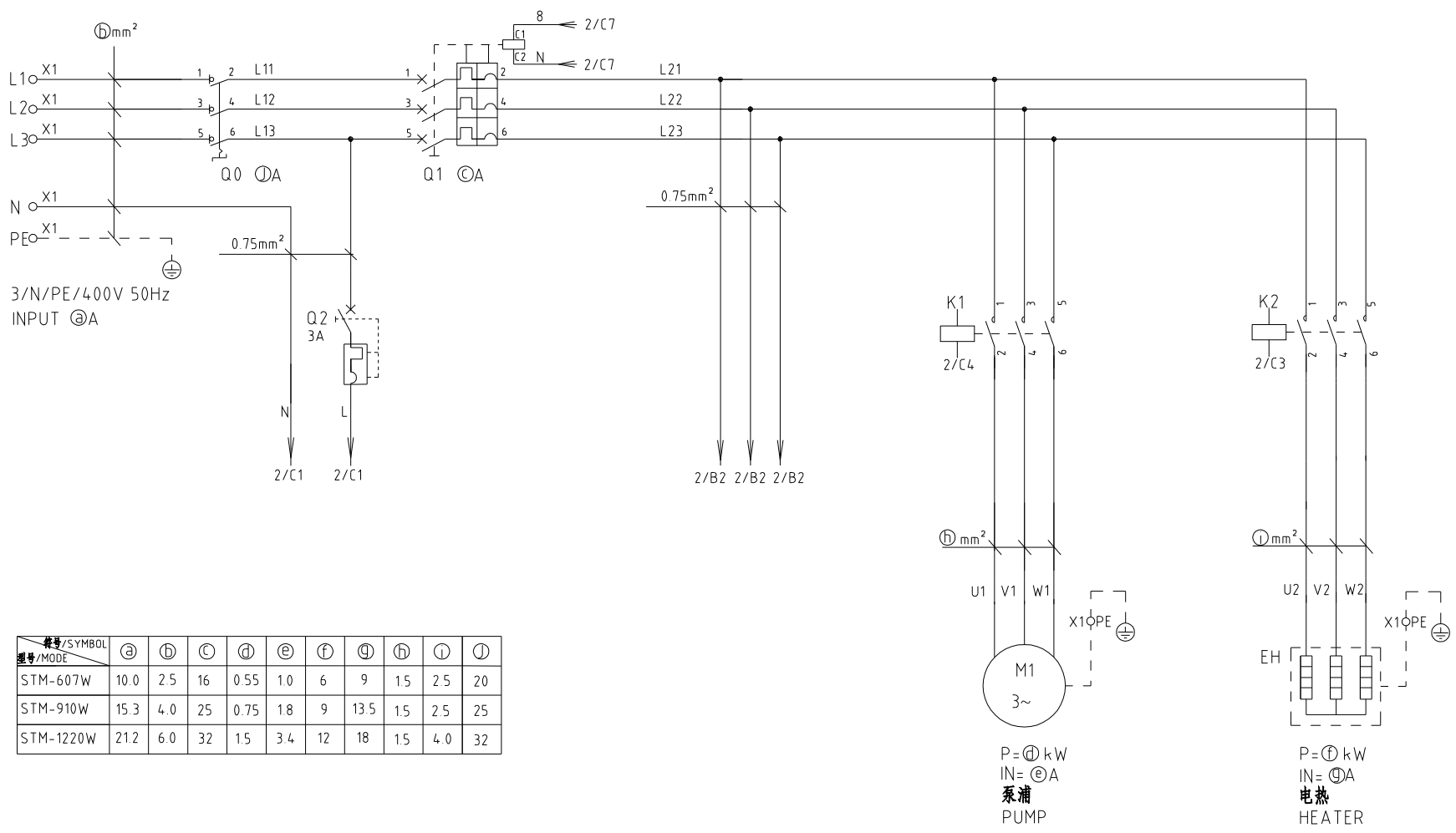

符号/SYMBOL 型号/MODE	ⓐ	ⓑ	ⓒ	ⓓ	ⓔ	ⓕ	ⓖ	ⓗ	ⓘ	ⓙ
STM-607W	10.0	2.5	16	0.55	1.0	6	9	1.5	2.5	20
STM-910W	15.3	4.0	25	0.75	1.8	9	13.5	1.5	2.5	25
STM-1220W	21.2	6.0	32	1.5	3.4	12	18	1.5	4.0	32

					制图		版号	D	标题	STM-607/910/1220W-EB	图号	STM-607/910/1220W-EB-400V-D-1	比例	第 1 张
					设计		核		主电路图				标准	GB
					校对		准						机器电压	3/N/400V
标记	更改前	更改后	更改人	日期	审核		日期	20221013					机器频率	50Hz



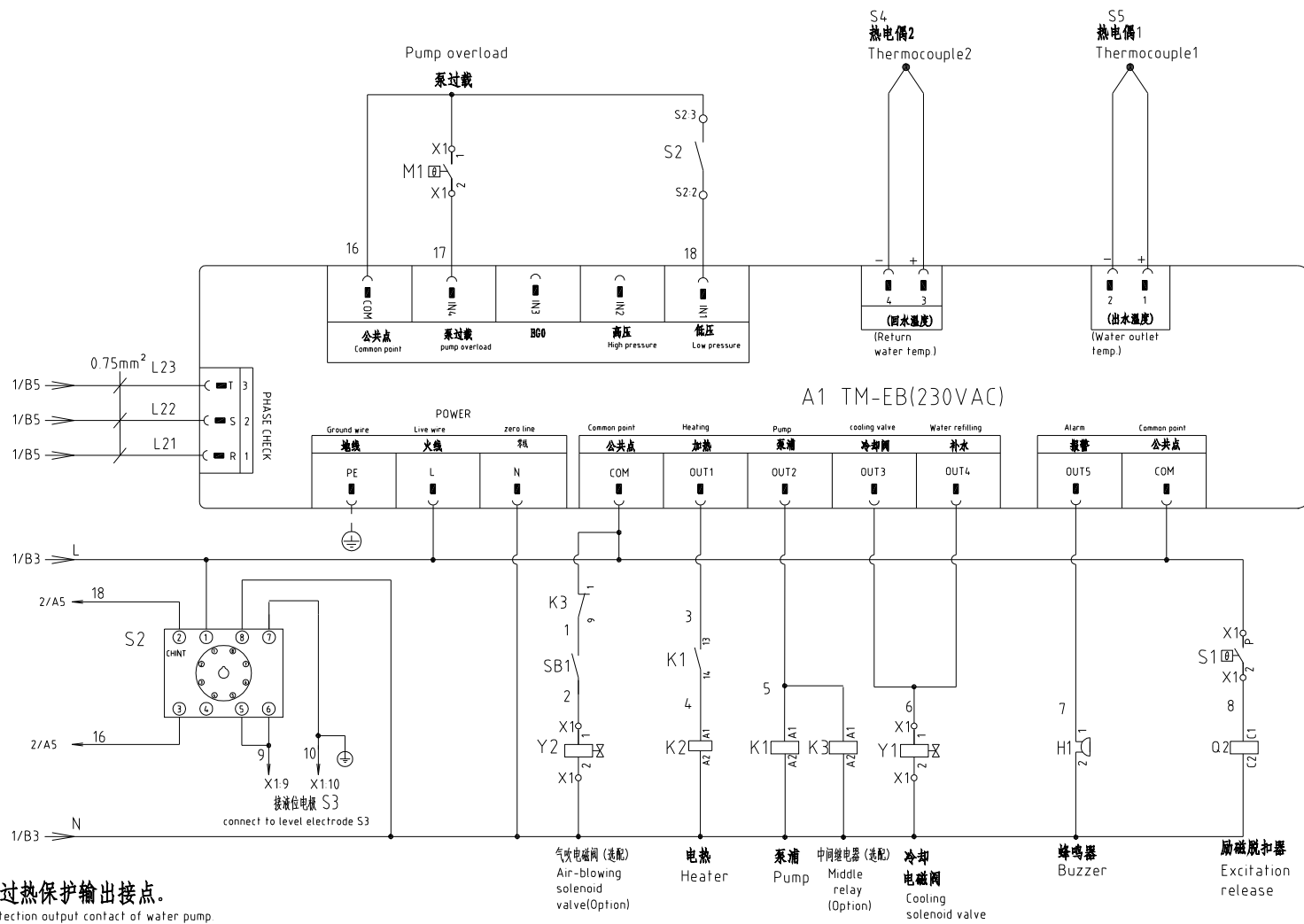

注: M1为水泵电机过热保护输出接点。
 Note: M1 is the overheat protection output contact of water pump.

					制图	版号	D	标题	STM-607/910/1220W-EB	图号	STM-607/910/1220W-EB-400V-D-2	比例	第 2 张
					设计	核准		控制电路图		标准	GB	共 5 张	
					校对	日期	20221013	 信易电热机械股份有限公司 Shini Plastics Technologies, Inc.		机器电压	3/N/400V		
标记	更改前	更改后	更改人	日期	审核	日期	20221013			机器频率	50Hz		

技术要求: (1)热电偶正(+)负(-)极直接接到线路板的热电偶输入端,不经过端子排。

(2)电热和泵浦直接接接触器输出端。

Technical requirements

(1) Positive (+) and negative (-) poles of thermocouple should be directly connected to thermocouple's input terminal of circuit board. There is no need for them to go through the terminal board.

(2) the heater and bump directly connect to contactor output.

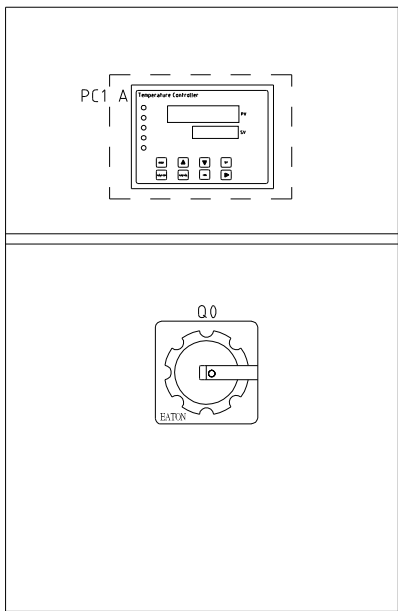

电箱面板
Electric box panel

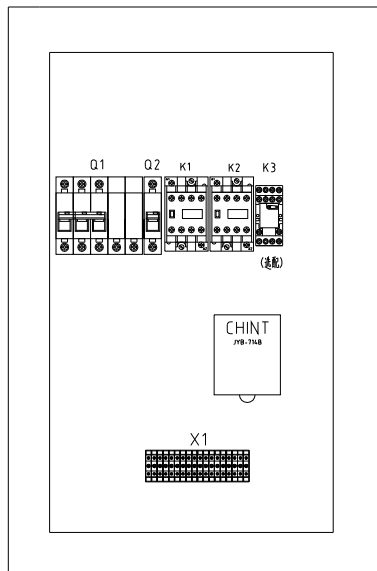

电箱底板
Base plate of electrical box

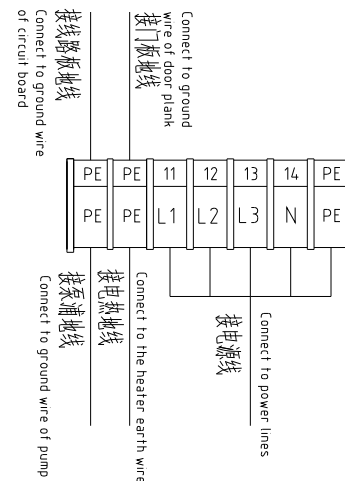
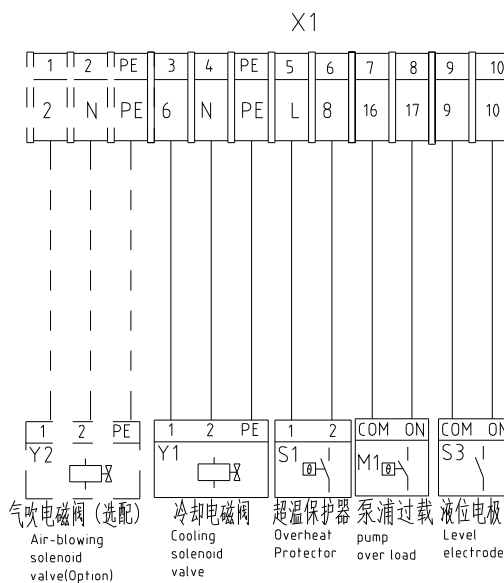

					制图		版号	D
					设计		核	
					校对		准	
标记	更改前	更改后	更改人	日期	审核		日期	20221013

标题		STM-607/910/1220W-EB		图号		STM-607/910/1220W-EB-400V-D-3		比例	第 3 张
		电气布置及端子接线图						标准	共 5 张
								机器电压	3/N/400V
								机器频率	50Hz



信易电热机械股份有限公司
Shini Plastics Technologies, Inc.

1	2	3	4	5	6	7	8		
序号/NO	符号/Symbol	名称/Name	制造商/Manufacturer	型号/Type	规格/Specification	数量/Number	物料编号/Material number	备注/Remark	
A	1	断路器/Circuit Breakers	TECO	BM-63C	16A	1	YE40301603000	607W-EB用 for 607W-EB	
	2	断路器/Circuit Breakers	TECO	BM-63S	25A	1	YE40302503000	910W-EB用 for 910W-EB	
	3	断路器/Circuit Breakers	TECO	BM-63C/3032S	32A	1	YE40303203000	1220W-EB用 for 1220W-EB	
	4	励磁脱扣器/Excitation release	CHINT	MX	230VAC	1	YE40023560000		
5	Q2	断路器/Circuit Breakers	TECO	BM-63C/1003S	3A	1	YE40100203000		
6	K1	接触器/Contactors	SIEMENS	3RT6015-1AN21	220V 50/60Hz	1	YE00601521000		
7	K2	接触器/Contactors	SIEMENS	3RT6018-1AN21	220V 50/60Hz	1	YE00601800000	607W-EB用 for 607W-EB	
B	8	接触器/Contactors	SIEMENS	3RT6026-1AN20	220V 50/60Hz	1	YE00602622000	910W-EB用 for 910W-EB	
	9	接触器/Contactors	SIEMENS	3RT6027-1AN20	220V 50/60Hz	1	YE00602722000	1220W-EB用 for 1220W-EB	
	10	K3	中间继电器/Middle relay	WEIDMULLER	DRM270730LT	220V 50/60Hz	1	YE03270700000	(2)
	11	SB1	切换开关/Alternative switch	----	R210-C5LBW4P	220V 50/60Hz	1	YE10210400000	(2)
	12	A1 TM-EB	线路板/Circuit Board	YUYUN	TM-EB 220VAC 宇韻 YuYun	180~430V 50/60Hz	1	YE81081100100	
	13	H1	蜂鸣器/Buzzer	SHINI	PF-35A	230VAC 50Hz	1	YE84003500000	
	14								
C	15	X1	端子排/Terminal Board	PHOENIX	2.5mm ²	----	12	YE61250040000	607W-EB用 for 607W-EB
	16		接地端子排/Grounding terminal board	PHOENIX	2.5mm ² PE	----	4	YE61253500000	607W-EB用 for 607W-EB
	17		端子排/Terminal Board	PHOENIX	2.5mm ²	----	8	YE61250040000	910W-EB用 for 910W-EB
	18		接地端子排/Grounding terminal board	PHOENIX	2.5mm ² PE	----	1	YE61253500000	910W-EB用 for 910W-EB
	19		端子排/Terminal Board	PHOENIX	4.0mm ²	----	4	YE61040000000	910W-EB用 for 910W-EB
	20		接地端子排/Grounding terminal board	PHOENIX	4.0mm ² PE	----	3	YE61043500000	910W-EB用 for 910W-EB
	21		端子排/Terminal Board	PHOENIX	2.5mm ²	----	8	YE61250040000	1220W-EB用 for 1220W-EB
	22		接地端子排/Grounding terminal board	PHOENIX	2.5mm ² PE	----	1	YE61253500000	1220W-EB用 for 1220W-EB
	23		端子排/Terminal Board	PHOENIX	6mm ²	----	4	YE61060000000	1220W-EB用 for 1220W-EB
	24		接地端子排/Grounding terminal board	----	6mm ² PE	----	3	YE61063500000	1220W-EB用 for 1220W-EB
25									

注: (1)表示非电控箱内材料; (2)表示气吹功能选配件; (3)表示选装出水回水温度显示功能;

Notes: (1)Means it's not the material inside the control box. (2)Means it is optional with air-blowing function. (3)Means equipped with function of displaying water outlet and return water temperature.

D						制图	版号	D	标题	STM-607/910/1220W-EB	图号	STM-607/910/1220W-EB-400V-D-4	比例	第 4 张	
						设计	核	准	元件明细表一		标准	GB	共 5 张		
						校对					 信易電熱機械股份有限公司 Shini Plastics Technologies, Inc.	机器电压	3/N/400V		
	标记	更改前	更改后	更改人	日期	审核	日期	20221013	机器频率	50Hz					
1		2		3		4		5		6		7		8	

1	2	3	4	5	6	7	8	
序号/NO	符号/Symbol	名称/Name	制造商/Manufacturer	型号/Type	规格/Specification	数量/Number	物料编号/Material number	备注/Remark
A	M1	马达/Motor	SHINI	TP-55	400V 50Hz 0.55kW	1	----	(1) 607W-EB用 for 607W-EB
		马达/Motor	SHINI	TP-75	400V 50Hz 0.75kW	1	----	(1) 910W-EB用 for 910W-EB
		马达/Motor	SHINI	TP-150	400V 50Hz 1.5kW	1	----	(1) 1220W-EB用 for 1220W-EB
	EH	电热/Heater	SHINI	6kW	400V 50Hz	1	----	(1) 607W-EB用 for 607W-EB
		电热/Heater	SHINI	9kW	400V 50Hz	1	----	(1) 910W-EB用 for 910W-EB
		电热/Heater	SHINI	12kW	400V 50Hz	1	----	(1) 1220W-EB用 for 1220W-EB
	S1	超温保护器/Overheat Protector	----	KSD301-12.5/10BL16K20	125℃	1	YE90030100000	(1)
B	S2	液位控制器/Level controller	CHINT	JYB-714B	230VAC 50/60Hz	1	YE03071400000	(1)
	S3	液位电极/Level electrode	----	----	----	1	YE90815970000	(1)
	S4	热电偶/Thermocouple	SHINI	----	K	1	----	(1) (3)
	S5	热电偶/Thermocouple	SHINI	----	K	1	----	(1) (3)
	Y1	电磁阀/Solenoid Valve	----	----	230VAC 50/60Hz	1	----	(1)
	Y2	电磁阀/Solenoid Valve	----	----	230VAC 50/60Hz	1	----	(1) (2)
	X1	端子排/Terminal Board	PHOENIX	2.5mm ²	----	2	YE61250040000	(2)
C		接地端子排/Grounding terminal board	PHOENIX	2.5mm ² PE	----	1	YE61253500000	(2)
	Q0	主电源开关/Main power switch	EATON	T0-2-1/EA/SVB	20A	1	YE10021160000	607W-EB用
		主电源开关/Main power switch	EATON	P1-25/EA/SVB	25A	1	YE10125250000	910W-EB用
		主电源开关/Main power switch	EATON	P1-32/EA/SVB	32A	1	YE10323200000	1220W-EB用

注: (1)表示非电控箱内材料; (2)表示气吹功能选配件; (3)表示选配出水 and 回水温度显示功能;
Notes: (1)Means it's not the material inside the control box (2)Means if is optional with air-blowing function (3)Means equipped with function of displaying water outlet and return water temperature

D						制图	版号	D	标题	STM-607/910/1220W-EB	图号	STM-607/910/1220W-EB-400V-D-5	比例	第 5 张
						设计	核		元件明细表二		标准	GB	共 5 张	
						校对	准		 信易电热机械股份有限公司 Shini Plastics Technologies, Inc.		机器电压	3/N/400V		
	标记	更改前	更改后	更改人	日期	审核	日期	20221013			机器频率	50Hz		
	1	2	3	4	5	6	7	8						