

SG-EB

"Budget" Central Granulator

Date: Oct. 2022

Version: Ver.A (English)



Contents

1. General Description	6
1.1 Coding Principle.....	7
1.2 Feature	7
1.3 Dimensions	9
1.4 Safety Regulations.....	10
1.4.1 Safety Signs and Labels.....	10
1.4.2 Transportation and Storage of the Machine	11
1.5 Exemption Clause.....	13
2. Structural Features and Working Principle.....	14
2.1 General Description	14
2.1.1 Working Principle.....	14
2.2 Safety System.....	15
2.2.1 Emergency Stop.....	15
2.2.2 Safety Switch.....	15
2.2.3 Locking Screw	16
2.3 Options Installation	17
2.3.1 Special Screen	17
2.3.2 Direct Feed Box.....	17
2.3.3 Other Options	17
3. Installation and Debugging	18
3.1 Power Connection.....	19
3.2 Installation Place.....	19
3.3 Installation Notice.....	20
4. Operation Guide	21
4.1 Prestart Check	21
4.1.1 Two Hours after First Start	21
4.2 Start / Stop of the Machine	21
4.3 Open the Feed Box, Screen and Collection Box.....	22
5. Trouble-Shooting	23

5.1 Granulator Can Not Work	23
6. Maintenance and Repair	25
6.1 Installation of Blade-rest and Bearing	26
6.1.1 Blade-rest Shaft Installation.....	26
6.1.2 Material Fender Installation	26
6.2 Installation of Motor, Belt and Pulley	27
6.4 Installation of Screen, Screen Bracket and Collection Box.....	28
6.2.1 Blade Replacement	29
6.3 Blade Installation.....	30
6.4 Transmission	32
6.4.1 Daily Maintenance of V Belts.....	32
6.4.2 Adjustments of V Belts	33
6.5 Lubrication	34
6.5.1 Lubricating Oils (Brands)	34
6.5.2 Lubricating Method.....	34
6.6 Maintenance	35
6.6.1 Daily Check	35
6.6.2 Weekly Check	35
6.6.3 Monthly Check.....	35
6.7 Cleaning.....	36
6.8 Maintenance Schedule	37
6.8.1 About the Machine.....	37
6.8.2 Check After Installation.....	37
6.8.3 Daily Check	37
6.8.4 Weekly Check	37
6.8.5 Monthly Check.....	38
6.8.6 Check Half-yearly or Every 1000 Running Hours	38
6.8.7 3 Year Checking.....	38

Table Index

Table 1-1: Technical Specifications	9
---	---

Picture Index

Picture 1-1: Dimensions.....	9
Picture 2-1: Working Principle.....	14
Picture 2-2: Emergency Stop	15
Picture 2-3: Safety Switch.....	16
Picture 2-4: Locking Screw	16
Picture 3-1: Installation Place	19
Picture 3-2: Installation Space	20
Picture 4-1: Start / Stop of the Machine	22
Picture 5-1: Emergency Stop Button.....	23
Picture 6-1: Blade-rest Shaft Installation.....	26
Picture 6-2: Material Fender Installation	26
Picture 6-3: Flat Key	27
Picture 6-4: Big and Small Pulley.....	27
Picture 6-5: Motor	27
Picture 6-6: Installation of Bearing, Motor, Pulley and Belt	28
Picture 6-7: Installation of Screen Bracket.....	28
Picture 6-8: Screen Installation.....	28
Picture 6-9: Collection Box Installation.....	29
Picture 6-10: Open the Cutting Chamber.....	29
Picture 6-11: Blade Replacement	30
Picture 6-12: Pressing Block.....	30
Picture 6-13: Fixing Screws of Pressing Block.....	31
Picture 6-14: Rotating Blade Assembly.....	31
Picture 6-15: Installation of Rotating and Fixed Blade	31
Picture 6-16: Maintenance of V Belts.....	33
Picture 6-17: Adjustments of V Belts 1.....	33
Picture 6-18: Adjustments of V Belts 2.....	33
Picture 6-19: Lubricating Method	34
Picture 6-20: Star Knobs.....	35

1. General Description



Please read this manual carefully before using this machine in order to operate correctly against any damage caused due to improper operation.



Note!

Always take great care when the knives are within reach, they are very sharp and can cause personal injury.



Forbidden to process flammable or toxic material!

This serie of SG-EB has no difference with the standard model in structure and operation for safety, but more of energy saving as well. The granulators are applicable to granulate various kinds of plastic materials from injection molding, blow molding or wasted materials.



Model :SG-2130EB

1.1 Coding Principle

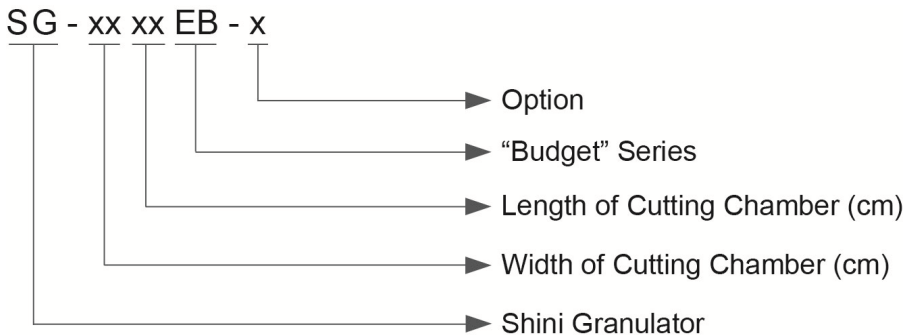

1.2 Feature

- Staggered blades design can decentralize working load when granulating to increase cutting efficiency(SG-60110EB adopts paddle-blade structure.)
- Cutters adjustment are available. Shaping after blunt ensures longer life service.
- Optimal cutting angle makes resistance small and avoid blockage to improve cutting efficiency.
- Adopt adjustable bearing with base, mounted outside of cutting chamber's side plate of bearing for convenient installation and maintenance.
- Optimal design can effectively reduce vibration during operation of granulator.
- Equipped with motor overload relay and multiple safety devices to ensure machine safe operation.
- SG-3260EB and the models below it are equipped with castor on their bottom. They have small size and are easy to move.
- Economic structure design can reduce the cost of replacement parts.
- For Fiber Reinforced materials, full fiber reinforced model is optional. Adopt surface-hardening treatment on the material contacting components blade material is V-4E joint with S50C.

All service work should be carried out by a person with technical training or corresponding professional experience. The manual contains instructions for both handling and servicing. Chapter 6, which contains service instructions intended for service engineers. Other chapters contain instructions for the daily operator.

Any modifications of the machine must be approved by SHINI in order to avoid personal injury and damage to machine. We shall not be liable for any damage caused by unauthorized change of the machine.

Our company provides excellent after-sales service. Should you have any problem during using the machine, please contact the company or the local vendor.

Shini Hotline Service:

Headquarter and Taipei factory:

Tel: + 886 (0)2 2680 9119

Shini Plastics Technologies (Dongguan), Inc.:

Tel: +86 (0)769 8331 3588

Shini Plastics Technologies (Pinghu), Inc.:

Tel: +86 (0)573 8522 5288

Shinden Precision Machinery (Chongqing), Inc.:

+86 (0)23 6431 0898

1.3 Dimensions

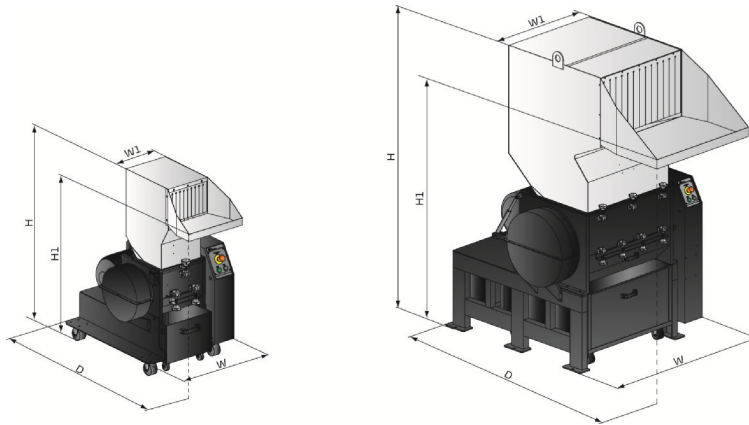

Picture 1-1: Dimensions

Table 1-1: Technical Specifications

Model	SG-2130EB	SG-2540EB	SG-2950EB	SG-3260EB	SG-4880EB	SG-60110EB
Motor Power (kw)	5.5	7.5	11	15	22	30
Rotating Speed (rpm)	540	540	540	450	525	525
Material of Blades	Cr12Mo1V1	Cr12Mo1V1	Cr12Mo1V1	Cr12Mo1V1	Cr12Mo1V1	Cr12Mo1V1
Quantity of Fixed Blades	Staggered	Staggered	Staggered	Staggered	Staggered	Paddle
Quantity of Fixed Blades	2	2	2	4	4	4
Quantity of Rotating Blades	3×3	3×4	3×5	3×6	3×8	3×2
Cutting Chamber (mm)	210×300	250×400	290×500	320×600	480×800	600×1100
Max. Output (kg/hr)	150~200	200~250	250~300	300~350	450~600	700~1000
Noise Level dB(A)	105~110	105~110	105~110	105~110	105~110	110~115
Screen (mm)	✓(Φ8)	✓(Φ8)	✓(Φ8)	✓(Φ8)	✓(Φ12)	✓(Φ12)
Flywheel	✓	✓	✓	✓	✓	✓
H (mm)	1200	1385	1450	1600	2320	2758
H1 (mm)	1008	1156	1173	1293	1725	2200
W (mm)	694	795	904	1029	1302	1670
W1 (mm)	300	400	500	600	800	1100
D (mm)	1105	1330	1430	1515	2049	2472
Weight (kg)	400	470	550	720	1600	2000

Note: 1) ✓ " stands for standard, "

2) Cr12Mo1V1 is corresponding to SKD11 under Japanese JIS standard .

3) When granulating fibers reinforced plastics or materials alike (e.g. CPVC), it is suitable to select granulators with special quenching process in for cutting chamber and blades, and also add "F" at end of the model code.

4) Max. capacity of the machine is subject to diameter of screen mesh and composition of material.

5) Noise level varies with different materials and motor types.

6) To avoid plastic from sticking to the blades, all materials should be crushed at normal temperature.

7) Power supply : 3Φ, 230/400/460/575VAC, 50/60Hz.

1.4 Safety Regulations

Follow the instructions in this manual to avoid personal injury and damage to machine components.

The following safety measures shall be followed when operating the granulator.

1.4.1 Safety Signs and Labels



Electrical installation must only be done by a competent electrician!



Before the granulator is opened for servicing and maintenance, always disconnect the power with both the main switch and the control switch on the granulator.



Never put any part of your body through the granulator openings, unless both the main switch and the control switch on the granulator are in "Off" position.



High voltage! Danger!

This sign is attached on the control box and the wiring box.



Be careful with the rotating knives, they are very sharp and can cause personal injury!



If the rotor must be turned manually-do this with great care!



The granulator should not be able to start before the hopper and screen bracket are properly closed.



Attention please!

Ear protection is used during granulating of plastic materials.



Never remove protective sponge or quick coupling clips adjacent to the outlet of storage bin.



Make sure the power has been cut off before opening the feed box.



Air inlet dust clean.



Attention!

No need for regular inspection because all the electrical parts in the control unit are fixed tightly!



Attention!

The SG-4880EB has a shutdown delay function. After pressing the stop button, it won't stop until the time set by the timer is up; Emergency stop and safety switch are not controlled by time delay. Please be noted to operate it correctly!

1.4.2 Transportation and Storage of the Machine

Transportation

- 1) SG-EB series of granulators are packed in plywood cases with wooden pallet at the bottom, suitable for quick positioning by fork lift.
- 2) SG-3260EB and models below are equipped with castors for easy transport after package dismantling. As SG-4880EB&SG-60110EB are large machines without castor, which requires forklift for transport.
- 3) Do not rotate the machine and avoid collision with other objects during transportation to prevent improper functioning.
- 4) The structure of the machine is well-balanced, although it should also be handled with care when lifting the machine for fear of falling down.
- 5) The machine and its attached parts can be kept at a temperature from -25°C to $+55^{\circ}\text{C}$ for long distance transportation and for a short distance, it can be transported with temperature under $+70^{\circ}\text{C}$.

Storage

- 1) SG-EB series should be stored indoors with temperature kept from 5°C to 40°C and humidity below 80%.
- 2) Disconnect all power supply and turn off main switch and exigency stop switch

- 3) Keep the whole machine, especially the electrical components away from water to avoid potential troubles caused by the water.
- 4) Use plastic film to cover the machine tightly to prevent the machine from dust and rains.

Working environment

The machine should be operated:

- 1) Indoors in a dry environment with max. temperature +45°C and humidity no more than 80%.

Do not use the machine:



- 1) If it is with a damaged cord.
- 2) On a wet floor or when it is exposed to rain to avoid electric shock.
- 3) If it has been dropped or damaged until it is checked or fixed by a qualified serviceman.
- 4) This equipment works normally in the environment with altitude over 3000m.
- 5) At least 1m surrounding space is requested when this equipment is running. Keep this equipment away from flammable sources at least two meters.
- 6) In the work area of vibration and strong magnetic force

Rejected parts disposal

When the equipment has run out its life time and can not be used any more, unplug the power supply and dispose of it properly according to local code.



Fire hazard!

In case of fire, CO₂ dry powder fire extinguisher should be applied.



Flammable materials or materials which are contaminated by flammable substances/liquid may not be processed in the granulator. Serious risk of fire or explosion may cause personnel injury.



It is very important to tighten the screw as required torque.



When process item is longer than feed port, please cut long items into half until the length is shorter before processing.



Please don't put materials into the granulator if they are thinner than 2 mm and are soft and flexible, like rubber.

1.5 Exemption Clause

The following statements clarify the responsibilities and regulations born by any buyer or user who purchases products and accessories from SHINI (including employees and agents).

SHINI is exempted from liability for any costs, fees, claims and losses caused by reasons below:

- 1) Any careless or man-made installations, operation and maintenances upon machines without referring to the Manual prior to machine using.
- 2) Any incidents beyond human reasonable controls, which include man-made vicious or deliberate damages or abnormal power, and machine faults caused by irresistible natural disasters including fire, flood, storm and earthquake.
- 3) Any operational actions that are not authorized by SHINI upon machine, including adding or replacing accessories, dismantling, delivering or repairing.
- 4) Employing consumables or oil media that are not appointed by SHINI.

2. Structural Features and Working Principle

2.1 General Description

SG-EB granulator is designed for grinding plastic waste to granulate for recycling. The plastic waste should be free from metal parts and contamination before granulating. Mount magnet at the feed port to prevent metal scraps from getting into cutting chamber and brings damage to the blades. The granulator is controlled by start/stop and emergency stop button on control panel.

2.1.1 Working Principle

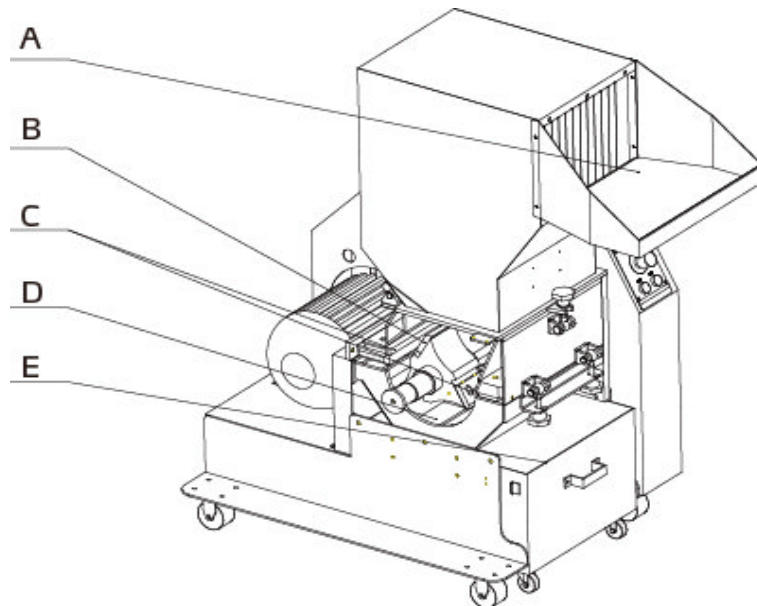

Parts name:

A. Feed port B. Rotating blades C. Fixed blades D. Screen E. Storage bin

Picture 2-1: Working Principle

The plastic waste is fed via feed port (A) and falls down into the cutting chamber, where rotating knives (B) cut the plastic waste against fixed knives (C) to granulate. A perforated screen (D) determines the size of the granulate. The screen is located in the lower section of the cutting chamber and can easily be changed to give the desired granulate size. The granulate passed the screen and falls down in the storage bin (E). After this, the granulate is ready for re-use in the production machine, or to be transported to a container for later use.

2.2 Safety System

The granulator has knives which rotate at high speed, therefore equip-ped with a safety system to avoid personal injury. The safety system must not be changed or modified in any circumstances. If the safety sy-stem of granulator is changed or modified, the machine can be danger-ous to use, presenting a serious rick of personal injury.

Allmaintenance to the safety system of the granulator must be carried out by personnel with the necessary knowledge.

2.2.1 Emergency Stop

The granulator has an emergency stop button on the control panel and the emergency stop is activated by pressing the button. Resetting is effected by turning the button in the direction of arrow (anti-clockwise).

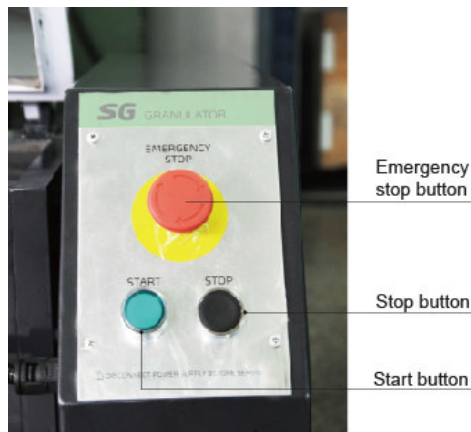

Picture 2-2: Emergency Stop

2.2.2 Safety Switch

Equipped with safety switch which will cut down the main power of machine stop from running if the collecting bin or feeding hopper opened.

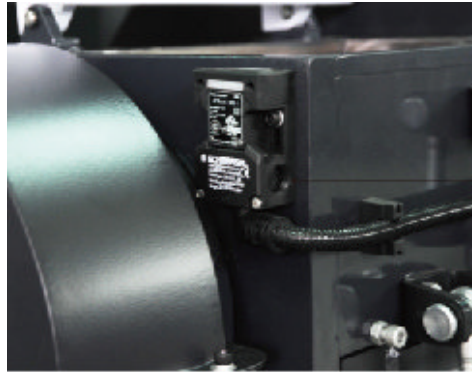

Safety switch

Picture 2-3: Safety Switch

2.2.3 Locking Screw

The star knobs which on the hopper and screen frame are very important components in the safety system of the granulator. When it unscrewed, the blades will be stopped. To avoid personal injuries.



Picture 2-4: Locking Screw

NOTE! Do not change the screw length of locking screw.

Before turning on the machine, the screws on feeding hopper and screen frame must be tightened to deadlock.

2.3 Options Installation

2.3.1 Special Screen

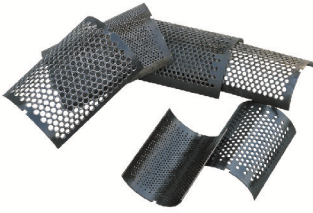

$\Phi 6, \Phi 10, \Phi 12$ and $\Phi 16$ are special diameters of sieve, being able to meet different production demands. $\Phi 10, \Phi 14$ and $\Phi 16$ are optional for SG-4880&SG-60110EB, and “SS” should be added at the end of its model code.

2.3.2 Direct Feed Box

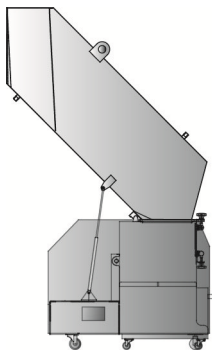

As to meet customer's demands on cutting strip thin-wall scraps (e.g. thin-walled strip automobile products), the direct feed box is optional for SG-3260EB.

2.3.3 Other Options

- Feed port and storage tank are made of stainless steel. Add “R” at the model behind.
- For Fiber Reinforced materials, full fiber reinforced model is optional. Adopt surface-hardening treatment on the material contacting components blade material is V-4E joint with S50C.

3. Installation and Debugging



Read through this chapter before installation.



Install as following orders to avoid any accident!



Be careful! Not to be cut by the sharp blade.



Power connection must be done by the professional electrician to avoid electrical shock.



Caution!

Cutters should be laid level, prevent the cutters from self-rotating during installation, don't let your hands be near to the cutters to avoid personal injury.



Notice!

Do not install the cutters by working together, because this could bring personal injury. Use a thick wood block to stop the rotating knives from turning.



Wear gloves to avoid being cut and be careful of the sharp blades!



Notice!

Please use new screws and gaskets when installing blades.



The power connection of the granulator should be carried out by professional electrician so to avoid electrical shock!

3.1 Power Connection

- 1) Make sure voltage and frequency of the power source comply with those indicated on the manufacture's plate, which is attached to the machine.
- 2) Power cable and earth connections should conform with local regulations.
- 3) Use independent power cable and ON / OFF switch. The cable's dia. Should not smaller than those applied in the control box.
- 4) The power cable connection terminals should be tightened securely.
- 5) The machine requires a 3-phase 4-wire power source, connect the power lead (L1, L2, L3) to the live wires, null line (N) and the earth (PE) to the ground.
- 6) Power supply requirements:
Main power voltage: +/- 10%
Main power frequency: +/- 2%
- 7) For detailed power connection specification, please refers to the circuit diagram of each model.

3.2 Installation Place



Make enough installation space to facilitate the repair and maintenance. Check and make sure the installation ground is level, and there is enough intensity when it is running.

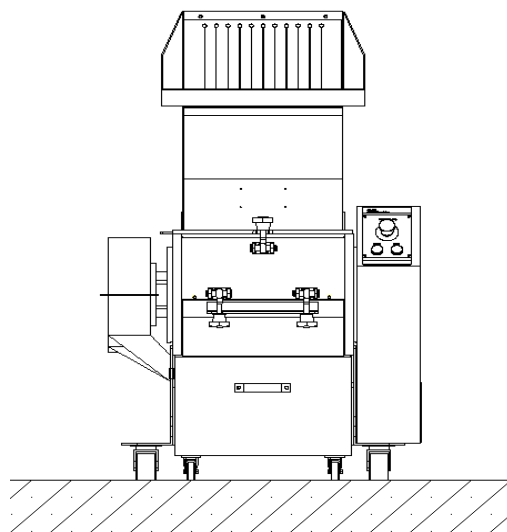

Picture 3-1: Installation Place

Make at least 1 meter clearance around the machine to facilitate repair and maintenance.

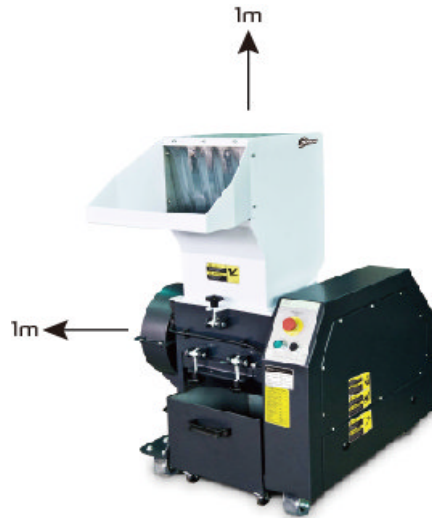

Picture 3-2: Installation Space

3.3 Installation Notice

- 1) Check that the emergency stop is not activated.
- 2) Check that the star knobs on the hopper and screen frame locks are fully tightened.
- 3) Start the machine.
- 4) Check that the granulator motor rotates in the direction indicated by the arrow on the cutter pulley.
- 5) If any direction of rotation should be incorrect:
 - a) Stop.
 - b) Switch off the main power.
 - c) Change two income wires of the motor.
 - d) Restart and recheck.

4. Operation Guide



Wear earplugs during operating to avoid personal injury!



Wear gloves during operating to avoid personal injury!



Wear goggles during operating to avoid personal injury!



Because the blades and rotor may be loosen, check the following items before operating:

- 1) If the blades has any damage;
- 2) If the surface of the rotor is loosen;

If any of the above situation is found, please contact local representative or SHINI company for help.

4.1 Prestart Check

1. The unpainted parts of the machine are protected with oil prior to delivery and transport. Clean the granulator from rust protection agent before it is used.

- a) Use dishcloth to clean firstly.
- b) Then use dishcloth with water to clean.

2. Check the distance of the blades (0.5~0.8mm) and tightening torque (Twisting force 90Nm).

4.1.1 Two Hours after First Start

Check the knife distance again, including rotating blades and fixed blades. Check the screws on them to see if there is any loosen one.

4.2 Start / Stop of the Machine

SG-EB series of granulator use the start and stop button located on the control panel for controlling.

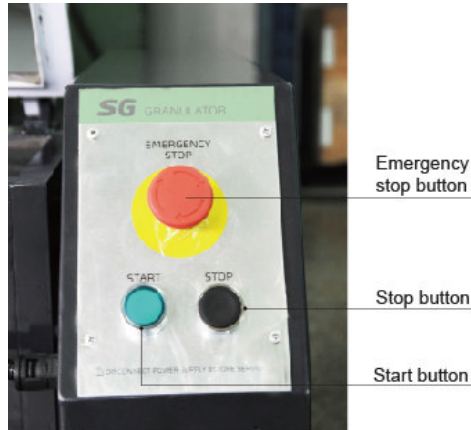

Picture 4-1: Start / Stop of the Machine

Note: Never stop the granulator before any material in the hopper or cutter chamber is completely granulated. Otherwise the residual material will clog the rotor in the granulator during restart. The motor will be overloaded and the overloading protection will trigger.

4.3 Open the Feed Box, Screen and Collection Box



Turn off the power before opening the feed box and screen and collection box of the SG-EB series of granulator.



Becareful!

The blades are very sharp and can cause personal injuries.



Caution!

Clean the inside surface of the feed box before closing it.

- 1) Check that the feed-in case is empty, and then stop the machine.
- 2) Loosen the star knobs on the feed box.
- 3) Open the feed box backwardly.

5. Trouble-Shooting

5.1 Granulator Can Not Work

- 1) Check if the emergency stop button is reset or not.

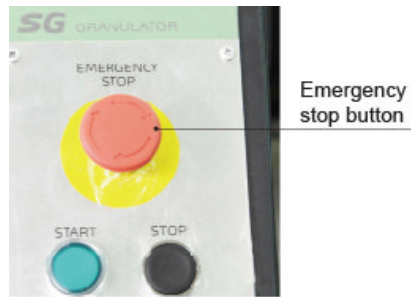

Picture 5-1: Emergency Stop Button

- 2) Check if the feed box is closed fully, if not, or the star knob has not been locked fully, the machine can not be started.



Picture 5-2: Star Knob

- 3) Check if the collection box is well installed, if it doesn't close fully or the bolt of the safety switch isn't inserted, the machine can not be started.



Picture 5-3: Safety Switch Pin

- 4) Check the overload relay of the motor. The motor equipped with overload protector F1 in the electrical control box if the motor is overload the protector will trip off. Trip button (blue) eject out, press "Reset" button to reset. Make sure there is no material retains in the granulator before restart the machine.

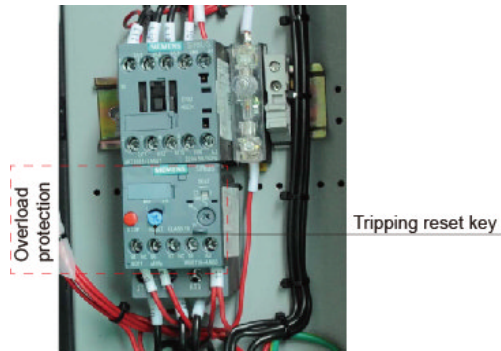

Picture 5-4: Overload Relay

- 5) Check the gap between the blades if the blades are too blunt or the gap between them is not properly, the machine will stop and the motor would be overload, the protector will trip off. Check the blades, replace it or readjust the gap.

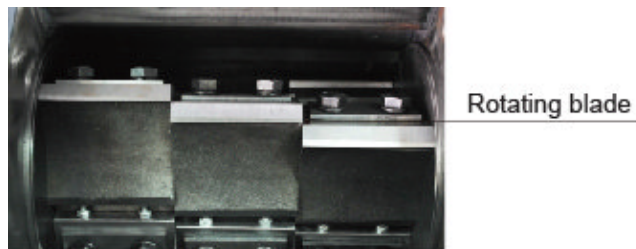

Picture 5-5: Cutter of Cutting Chamber

6. Maintenance and Repair

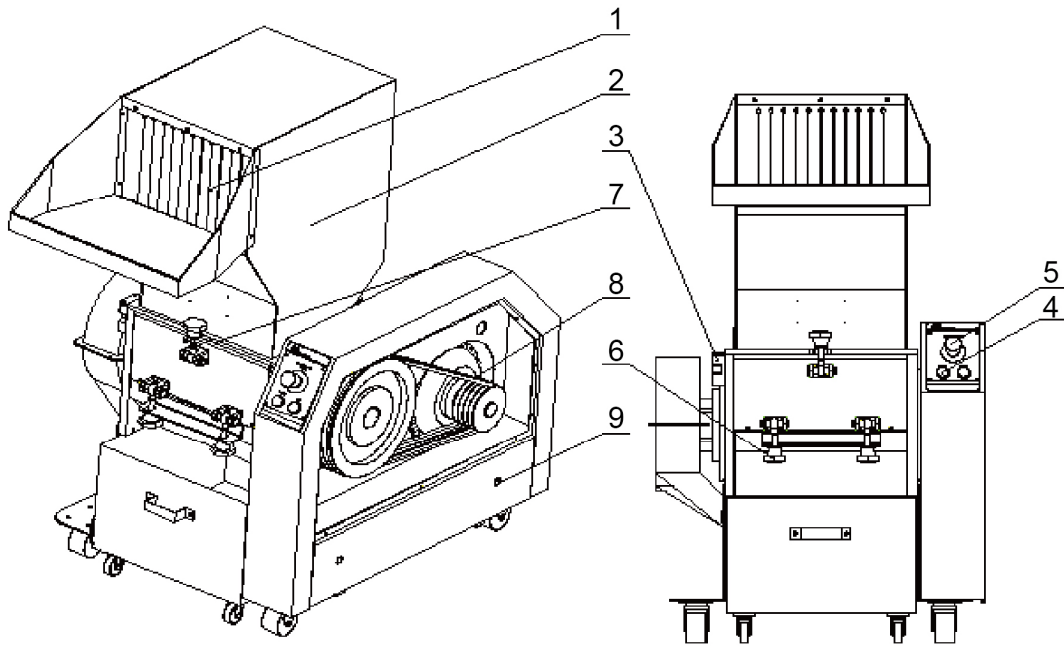

1. Check the material fender before machine start. Period: daily
2. Check there's metal in the cutting chamber before machine start. Period: daily
3. Check safety switch works normally or not. Period: daily
4. Check STOP/START button works normally or not. Period: daily
5. Check emergency stop button works normally or not. Period: daily
6. Check if there's screw loose of the fixed or rotating blade. Period: weekly
7. Check the screws of the feed box, screws on screen frame of cutting chamber. Period: weekly
8. Check belt tension. Period: monthly.
9. Check if there's contactor loose of the electrical components inside the control box. Period: monthly.

6.1 Installation of Blade-rest and Bearing

6.1.1 Blade-rest Shaft Installation

Blade-rest shaft is assembled by blade rest and shaft. Clean the blade rest and shaft before installation. Otherwise the dust and hard metal would cause unsmoothly assembly and damage. After cleaning, put the blade rest on the hydraulic machine. Then put the shaft into the blade rest and keep the shaft in vertical. Add the lubricant oil on the shaft to make smooth assembly.

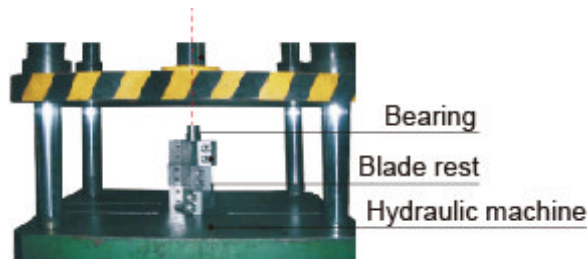

Picture 6-1: Blade-rest Shaft Installation

6.1.2 Material Fender Installation

First vertically put the blade rest, and mount the material fender on the shaft. Aim the 3 holes of countersunk head screws to the 3 M8 holes on the blade rest correctly. Add screw locking agent into the holes, and fix the 3 M8x20 countersunk head inner hexagon screws tightly.



Picture 6-2: Material Fender Installation

6.2 Installation of Motor, Belt and Pulley

- 1) Fix the cutting chamber and base, put the key into the key groove.

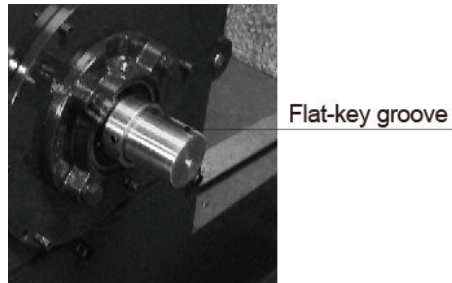

Picture 6-3: Flat Key

- 2) Mount the pulley on the shaft and the sleeve. Use the dial indicator to adjust the pulley and lock the sleeve.

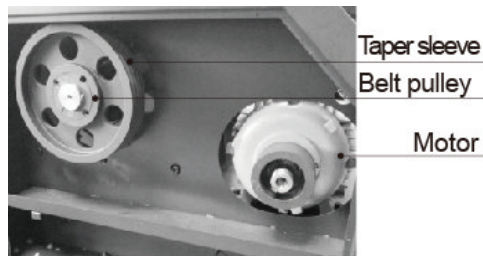

Picture 6-4: Big and Small Pulley

- 3) Mount the motor and adjusting board on the fixing board (do not lock the screw tightly).

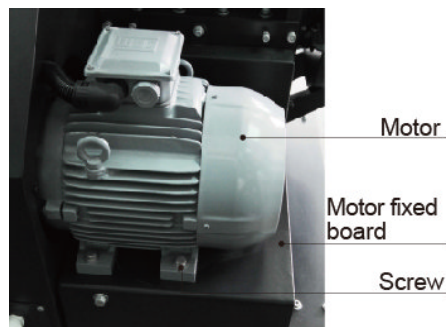

Picture 6-5: Motor

- 4) Fix the belt, and regulate the big and small pulleys with parallelism level ruler. Adjust belt tension and finally lock the motor screws tightly.

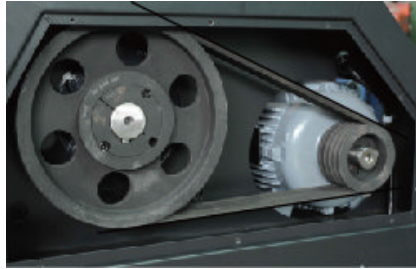

Picture 6-6: Installation of Bearing, Motor, Pulley and Belt

6.4 Installation of Screen, Screen Bracket and Collection Box

- 1) Hold the screen bracket and make the shaft through the holes on fixed plate and screen bracket. Hang it on the shaft of the screen bracket and fix it on the side fixing plates of cutting chamber.



Picture 6-7: Installation of Screen Bracket

- 2) Put the screen in the screen bracket .

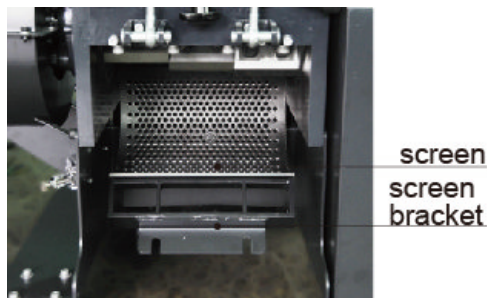

Picture 6-8: Screen Installation

- 3) Lift up the screen bracket, match it with the cutting chamber and fix them with star knobs tightly.
- 4) Put the collection box into the grooves on sides of rack.
- 5) Fixe the adjustable snap hook.

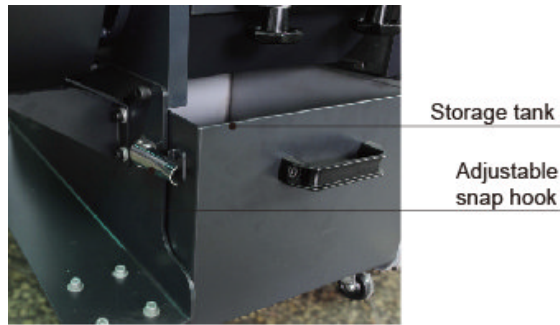

Picture 6-9: Collection Box Installation

6.2.1 Blade Replacement



CAUTION!

Wear gloves to avoid being cut and be careful of the sharp blades! Each time to replace the blade, the screws of blade must be replaced too.



CAUTION!

To decrease the possibility of harm to other people, the replacement action must be conducted by oneself. To avoid self-rotation, block the rotating blade with a thick wood block.

- 1) Withdraw the storage box, loose the star knobs. Open the screen bracket and take off the screen.

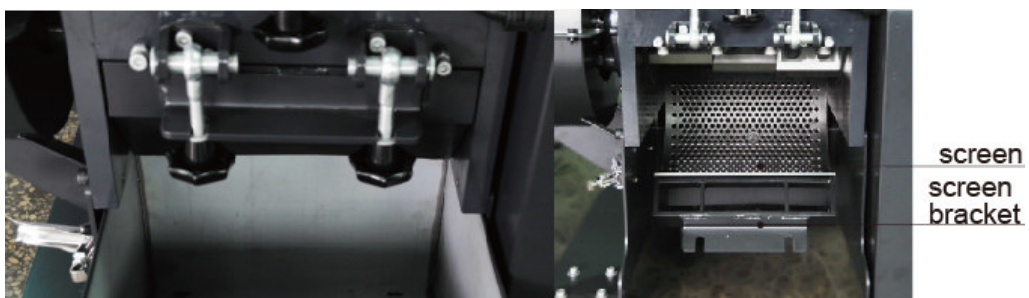

Picture 6-10: Open the Cutting Chamber

- 2) Loosen the screws on the pressing block of fixed blade and remove the fixed blade.
- 3) Loosen the screws on the pressing block of rotating blade and remove the rotating blade.

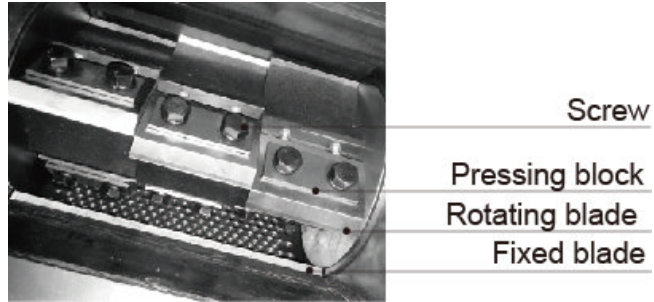

Picture 6-11: Blade Replacement

- 4) Remove pressing block and blade, clean the blade rest.
- 5) Replace new blade. During the replacement, check the screen, change with the new screen if there's any screen deformation.
- 6) Check the blades and rotate the blade rest, make sure all the blades work normally.

6.3 Blade Installation



Wear gloves to avoid being cut and be careful of the sharp blades !

- 1) Clean the front and rear blocks that mounted with fixed blades firstly, and clean the blade rest.
- 2) Insert the fixed blade and mount the rear pressing block on the fixed blade.

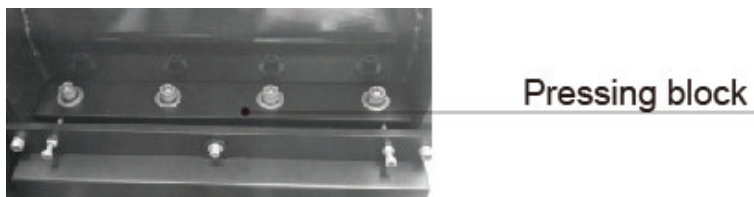

Picture 6-12: Pressing Block

- 3) Mount the hexagon screws on the adjusting holes of front and rear fixed blades for fixed blade gap adjusting.

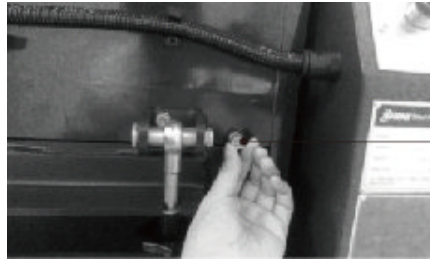

Fixed blade
fixation screw

Picture 6-13: Fixing Screws of Pressing Block

- 4) First adjust the screws on the rotating blade to keep 83mm distance from the end of screw. Put the rotating blade on the blade rest and aim the screw holes on it. Adjust the the screw on rotating blade to keep 0.5~0.8mm gap between the fixed blade. Add the screw locking agent then lock the screws on the rotating blade.

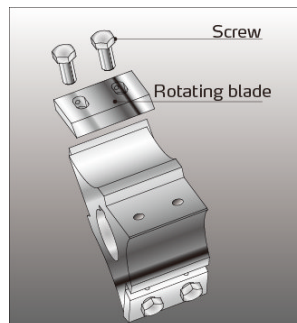

Picture 6-14: Rotating Blade Assembly

- 5) Put the feeler between the fixed blade and rotating blade, adjust the gap to 0.5~0.8mm (The gap can not be too close to avoid blade damage).
- 6) Lock the front and rear rotating blade tightly after gap adjustment.



Picture 6-15: Installation of Rotating and Fixed Blade

Notice: Screw for fixing rotating blade: hexagon M14x45mm,

strength:12.9, hardness: HRC41. Screw for fixing fixed blade of SG-2130EB: Inner hexagon M12x55mm, strength:12.9. Screw for fixing fixed blade of other machine: Inner hexagon M14x55mm, strength:12.9.

Caution: The screw must be tightened firmly to avoid human injury and machine damage!

Attention: Blade gap can not be too closed to avoid cutter damage!

Table 6-1: Attached Form, Cutters and Other Fixing Screw Torque

Thread size	M10	M12	M14	M16	M18	M20	M22	M24
Axial force(N)	23.8	34.5	47	65.5	78.5	103	129	149
Fixing torque (Nm)	50	86	135	215	290	420	570	730

6.4 Transmission

6.4.1 Daily Maintenance of V Belts

There are 4 V belts for the motor power.

1) Check the V belts

Check V belts' tensility after a full-load operation for 20-30 hours. And then check its abrasion condition monthly.

2) Check V belts' tensility every 6 months.

Remove the upper plate at right of the granulator. Rotate the V belts for several circles to see if there is any damage.

Caution: Pinch risk! Do not place your hands between wheels and the belts to avoid clipping. Check the belt tension. If it is necessary, adjust it.

a) Motor 7.5kW, enforce force 20N on the blade rest and belt of pulley, press down the belt not over 5mm.

b) Motor 11kW, enforce force 27N on the blade rest and belt of pulley, press down the belt not over 5mm.

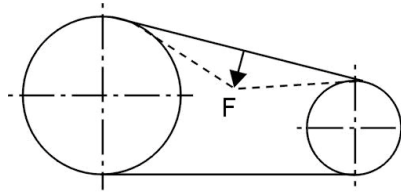

Motor power above 7.5kW

L=5mm F=20N

Motor power above 11kW

L=5mm F=27N

Picture 6-16: Maintenance of V Belts

6.4.2 Adjustments of V Belts

- 1) Detach the side plate on right control box of granulator
- 2) Remove the collection box, loose the adusting bolt under the motor to certain distance.



Picture 6-17: Adjustments of V Belts 1

- 3) Adjust the V belt's tension and distance between motor and pulley by adjusting the bolt on back of motor and lock the bolt tightly.



Picture 6-18: Adjustments of V Belts 2

- 4) Remember recheck the V belts' tensility after 20~30 hours' full load operation.

6.5 Lubrication

6.5.1 Lubricating Oils (Brands)

Xin Chang Long: FX-00
FX-000

Bp: BP Grease LGEP 2

ESSO: Beacon Ep2, Beacon EP2

Mobil: Mobilux EP2

Shell: Shell Alvania EP2

Texaco: Multifak Ep2, Novotex Grease EP2

6.5.2 Lubricating Method

Inject the lubricating oil to the oil inlet.

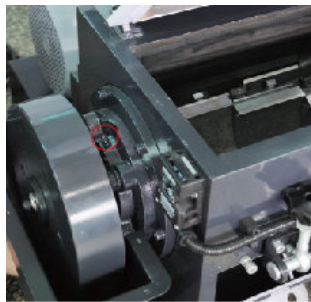

Picture 6-19: Lubricating Method

6.6 Maintenance

6.6.1 Daily Check

- 1) There is material fender in the feed-in box. If the material fender is damaged, replace it immediately.
- 2) Check whether the Emergency Stop works properly. Start the machine and then stop it via Emergency Stop. Rotate the button anti-clockwise to reset the Emergency Stop.
- 3) Check the star knob. Safety knob is a part of granulator's safety system. The length of it is set in advance. When the knob is loose, it would make cutting chamber open and cause human injury; the safety length is 55mm. If the knob is damaged, replace it immediately.

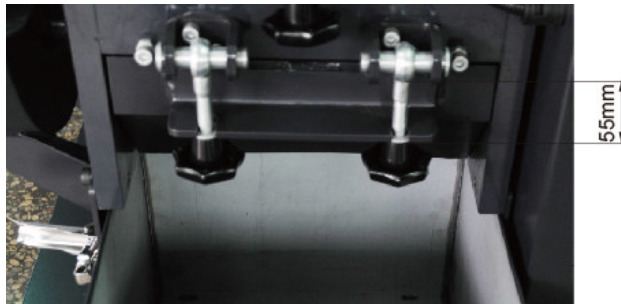

Picture 6-20: Star Knobs

6.6.2 Weekly Check

- 1) Check the power wire to see whether there is any damage. If so, replace it immediately.
- 2) Check the safety switch.
- 3) Check the safety switch at the connection of feed box and cutting chamber.

6.6.3 Monthly Check

- 1) Check the V belt to see whether there is any damage.
- 2) Check the belt's tensility every 6 months. More details to see chapter 6.2 Transmission.

6.7 Cleaning



CAUTION!

Make sure the main power switch is closed before cleaning!.



The blade may do harm to human body when opening the feed box!

- 1) Check whether the feed-in box is emptied before stopping the machine.
- 2) Clean the exterior surface of the feed box.
- 3) Clean the material inlet.
- 4) Open the feed box backforwardly.
- 5) Remove the material fender and clean it from both sides.



CAUTION!

Take care not to be cut by sharp blade when rotating the blade rest!

- 6) Open and clean the collection box and screen bracket.
- 7) Clean the inside and outside of the cutting chamber.
- 8) Blow to the clear material holes on left/right side plate of cutting chamber with compressed air. Rotate the blade rest at the same time, clean the pieces stucked inside the bearing base. Clean it daily.



CAUTION!

Use the safety contact switch with a protective shield to avoid anything.

6.8 Maintenance Schedule

6.8.1 About the Machine

Model _____ SN _____ Manufacture date _____

Voltage _____ Φ _____ V Frequency _____ Hz

Power _____ kW

6.8.2 Check After Installation

- Check if pipe connections are firmly locked by clips.
- Check the gap between fixed blade and rotating blade(0.5~0.8mm).
- Check the rotating balance of the belt wheel.

Electrical Installation

- Voltage: _____ V _____ Hz
- Specs of the fuse: 1 Phase _____ A 3 Phase _____ A
- Check phase sequence of the power supply.
- Check the rotating direction of the conveying blower.

6.8.3 Daily Check

- Check main power switch.
- Check emergency stop button.
- Check start / stop button.
- Check material fender (strip) is perfect or not.
- Check whether emergency stop and safety switch works normally.
- Clean screen and feed box.
- Check whether start, stop and power switches are normal.

6.8.4 Weekly Check

- Check all the electrical cables.
- Check if there are loose connections of electrical components.
- Check all the cutters.
- Check the screws of fixed blade and rotating blade.
- Check if there is abnormal noise, vibration and heat in gear motor.
- Check the cracking window

6.8.5 Monthly Check

- Check motor overload protective function.
- Check motor reverse function.
- Check if the cutters are tightened.
- Check if the locking ring of belt pulley is firmly or not.
- Check belt tension.

6.8.6 Check Half-yearly or Every 1000 Running Hours

- Check the bearings, motor and shaft lubrication
- Check the shaft holder
- Valuation of machine performance

6.8.7 3 Year Checking

- PC board renewal.
- No fuse breaker renewal.